

The KF Lock is a key operated mechanical bolt interlock for the control of electrical switchgear. The standard unit comes with a 16 mm diameter bolt of variable length, that is used to control the rotation or movement of operating handles or toggles of electrical switchgear. This lock is manufactured in brass or stainless steel.

OPERATION

The Castell KF bolt interlock range is used in switchgear control to inhibit movement of cams, toggles or levers.

KF bolt interlock, Form 4

1 Key is free, bolt is extended

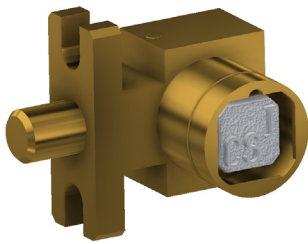

While the side bolt is extended, the key is free. The mechanism is locked.

2 Insert and turn key to drive bolt

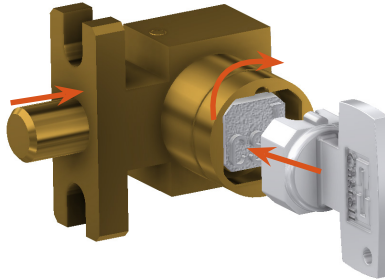

By inserting and turning the key in the bolt interlock, you can retract the bolt, e. g., releasing the disconnect. This will trap the key into the lock.

3 Key is trapped, bolt is retracted

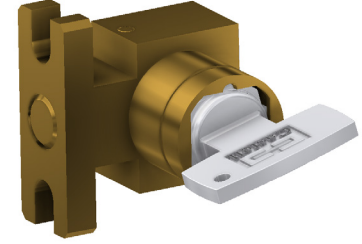

The key stays trapped while the bolt is retracted.

The bolt is available in various lengths to suit the application, but the travel of the bolt is always 19,05 mm. The key is free when the bolt is extended. Insertion and rotation clockwise of the key will retract the bolt. The key is trapped when the bolt is in the retracted position.

USAGE

The KF bolt interlocks are used as a part of a safety system to allow safe control of valves or disconnect switches.

 The KF bolt interlock is not designed for security purposes, such as access to a building.

The KF bolt interlock is not recommended for interlock access gates or doors. Please refer to AI access interlocks.

No hazardous substances were used in the manufacture of this product.

INSTALLATION

The housing of the KF bolt interlock should normally be mounted to a panel using suitable fasteners. Please refer to drawing on page 4 for more installation details.

 **IMPORTANT:** The interlock should be mounted using anti-tamper fasteners to prevent unauthorised removal.

 The KF bolt interlock must be installed by a competent and qualified person who has read and understood these instructions. Please retain this document in your technical file.

 Force required to shear lock bolt is 30 KN for stainless steel and 19 KN for brass interlocks.

 You must use M6 anti-tamper stainless steel screws secured using threadlock set to a torque of 5 N/M.

 The manufacturer should be consulted when use in a corrosive environment is planned.

MAINTENANCE

Periodic visual checks should be carried out by the site manager / safety officer.

Do not lubricate lock barrel with oil or grease, use CK dry powder graphite if necessary.

 In case of defects being detected please contact your nearest Castell Support Department for further actions. Please see Contact section for contact details.

 The interlock must be inspected every 6 months. Safety checks should include ensuring the keys and lock bolt can only be removed in the correct safety operating conditions (see page 1).

TECHNICAL DATA

Temperature rating	Minimum: -40°C [-40°F] ice free for Q & FS lock type
	Maximum: 107°C [224.6°F] for Q lock type/140°C [284°F] for FS lock type
Type of mounting	Surface mount using suitable fasteners (please refer to drawing on page 4 for more details)
Weight	Brass: 0.7 kg
	Stainless steel: 0.7 kg
Material	Brass/Stainless steel
B10d	2,500,000
Shock & vibration	EN 60068
PL rating	PLd

APPLICATION

The KF bolt interlock safety component is used as a part of an integrated safety system.

While power supply to the system is switched on, the access doors to the hazardous area are locked closed.

Key A is trapped in the disconnecter KF bolt interlock (1) while the process is on.

To enter the hazardous area, the disconnecter is turned to the off position and key A is turned and released, locking the disconnecter in the disengaged position.

Key A is then taken to the grounding switch. Key A is inserted and turned in the second KF lock (2) which retracts the bolt enabling the cammed switch lever to be rotated to engage the ground. Once rotated, the recess in the cam aligns with the next KF lock (3) with key B trapped in its lock. Key B can now be removed from KF lock (3), which now locks the lever in place ensuring that the ground connection cannot be broken.

The system is now disconnected and grounded, key B can be taken to operate the access interlock on the door of the hazardous area to gain access into it.

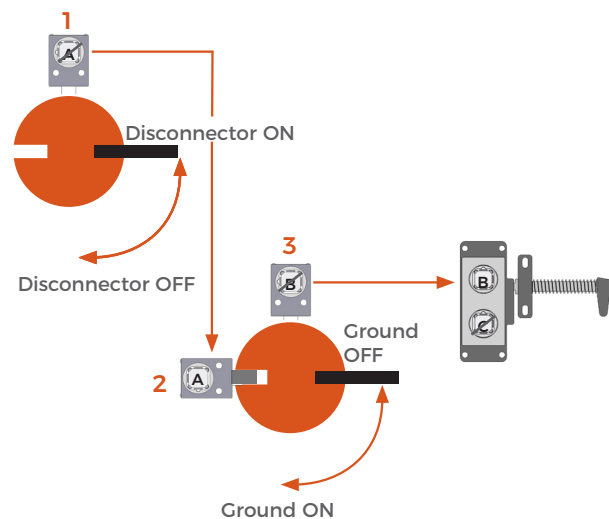

EC-DECLARATION

We, the manufacturers, declare that the components detailed herein and placed on the market comply with all the essential health and safety requirements applying to them.

ISO 13849-1:2015 Safety of Machinery

2006/42/EC Machinery Directive

Empowered signatory:

Kirstie Van Oerle
Business Unit Director 

DRAWING

Dimensions: in mm

Note: For safe mounting, use security screws

KF, form 4

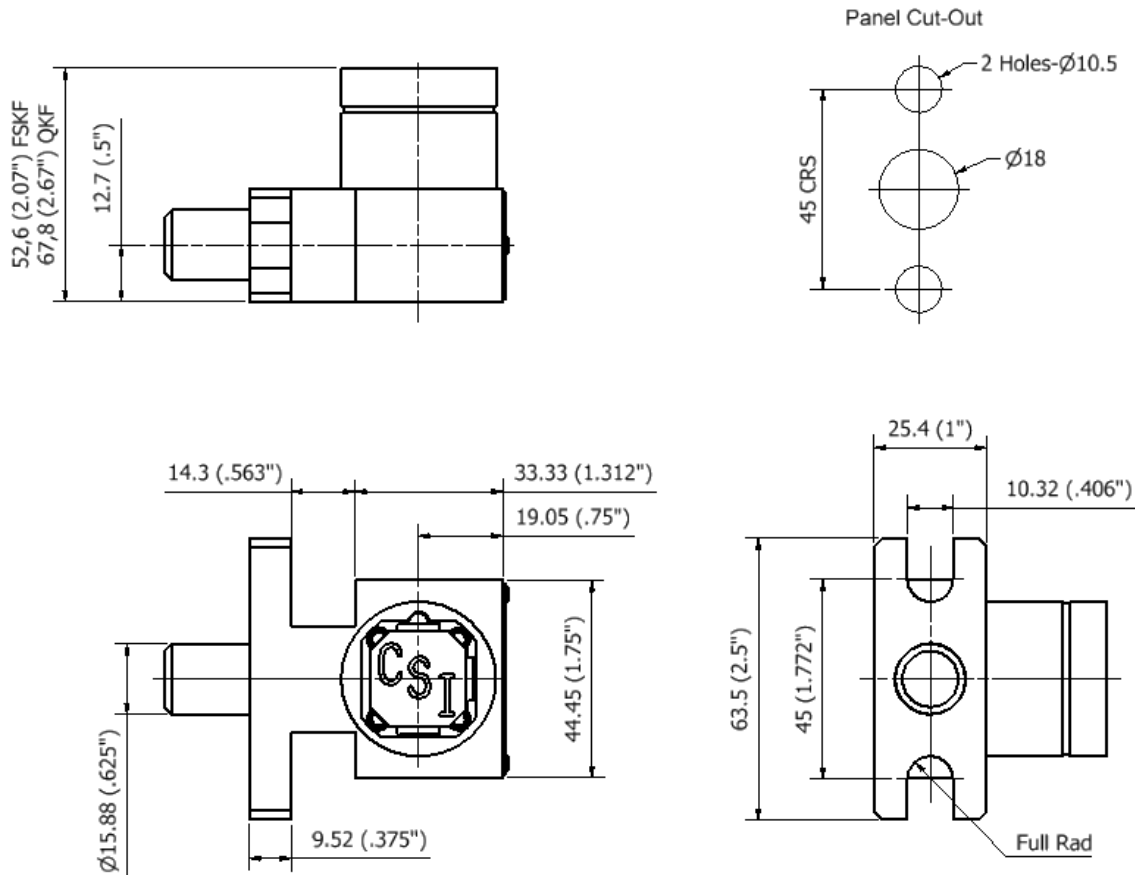



Mounting Holes:
M8 (Brass)
Ø8,35 (Stainless steel)
Ø10,3 (US - Brass/Stainless Steel)

L Dimension Retracted bolt length (in mm)	Extended bolt length (in mm)
0	19.05
6.35	25.40
12.70	31.75
19.05	38.10
25.40	44.45

ORDER INFORMATION

	Component type	1	2	3	4	5
Part number	KF					
Example	KF	FS	B	6.4	1	ABC

1	Lock portion type	FS ⁽¹⁾ / Q ⁽¹⁾
2	Material	B = Brass / S = Stainless steel
3	L dimension (bolt length when retracted) in mm	0 / 6.4 / 12.7 / 19.1 / 25.4
4	Form	1 / 2 / 3 / 4 ⁽²⁾
5	Lock portion symbol	FS ⁽¹⁾ up to 3 characters / Q ⁽¹⁾ up to 6 characters

(1)	FS - Lock type Up to 3 characters	Q - Lock type Up to 6 characters
		

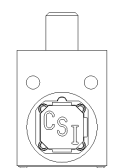
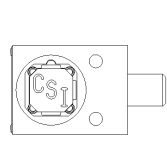
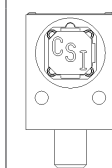
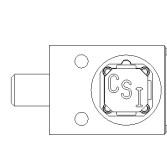
(2)	Form			
	1	2	3	4
				

Special construction available upon enquiry

ACCESSORIES

	Product	Part number
	Flip Cap	FLIP-S

CONTACT INFORMATION

Castell Safety

The Castell Building
217 Kingsbury Road
London, NW9 9PQ
UK

t: +44 (0)20 8200 1200
f: +44 (0)20 8205 0055
e: sales@castell.com

Castell Safety

Tower 185
60185 Frankfurt am Main
Germany

t: +49 (0)69 50 50 47 310
f: +49 (0)69 50 50 47 450
e: vertrieb@castell.com

Kirk Key Interlock

9048 Meridian Circle NW
North Canton, OH 47720
USA

t: +1 800 438 2442
f: +1 330 497 4400
e: sales@kirkkey.com

SPS China

2F, Building 63
No 421 Hongcao Road, Xuhui District
Shanghai PRC, 200233
China

t: +86 (0)21 6040 7398
f: +86 (0)21 5453 0630
e: chinasales@castell.com