

W Key Selector Box



The W key selector box is designed to enable the controlled release of keys by the positioning of a selector knob. It is typically used in switchgear applications ensuring multiple supplies are not applied to common bus bars. The W box is suitable for releasing any number of keys, in a pre-determined sequence in differing combinations. A maximum of six selector knob positions is available. The requirement for this type of product usually arises due to various system setups i.e. in the control of switchgear. The W box is supplied in an enclosure suitable for surface mounting.

OPERATION

Castell W key selector boxes are used in switchgear applications to ensure multiple supplies are not applied to common bus bars.

W key selector box, horizontal mount (5 keys)

- 1** Determine the required combination of trapped/released keys to operate the incomers and bus bars
- 2** Find the corresponding selector knob position in the truth table (containing all possible combinations pre-determined as per individual requirements)
- 3** Select the position of the selector knob (1-4) and release the required set of keys



W box front

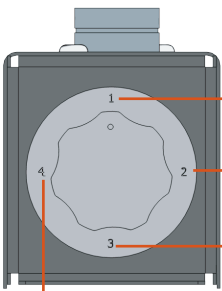

Selector Switch

	Inc 1	Inc 2	Inc 3	Bus 1	Bus 2
1	F	F*	F*	T	T
2	T	F	F*	F*	T
3	F*	T	F	F	T
4	F*	F*	T	T	F

F = free key

T = trapped key

* = key not returned between two neighbouring key free selections

USAGE

W key selector boxes should be used in switchgear applications to allow a safe access to potential hazardous and dangerous areas with one or more access points.

 The W key selector box is not designed for security purposes, such as access to a building.

No hazardous substances were used in the manufacture of this product.

INSTALLATION

The W key selector box should normally be mounted on the static frame using suitable fasteners (please refer to drawing on page 4 for more details). The W key selector boxes are available in horizontal and vertical mounting versions.

 You must use M6 anti-temper stainless steel screws secured using threadlock set to a torque of 5 N/M.

 The W key selector box must be installed by a competent and qualified person who has read and understood these instructions. Please retain this document in your technical file.

 The manufacturer should be consulted when use in a corrosive environment is planned.

MAINTENANCE

Periodic visual checks should be carried out by the site manager/safety officer.

Do not lubricate lock barrel with oil or grease, use CK dry powder graphite if necessary.

 In case of defects being detected please contact your nearest Castell Support Department for further actions. Please see Contact section for contact details.

 The interlock must be inspected every 6 months. Safety checks should include ensuring the keys can only be removed in the correct safety operating conditions (see page 1).

TECHNICAL DATA

Temperature rating	Minimum: -40°C [-40°F] ice free for Q & FS lock type
	Maximum: 107°C [224.6°F] for Q lock type/140°C [284°F] for FS lock type or 288°C [550°F] upon request
Type of mounting	Surface mount using suitable fasteners (please refer to drawing on page 4 for more details)
Weight	Brass: 1 kg for 2 lock portions, add 0.5 kg per additional portion
	Stainless steel: 1 kg for 2 lock portions, add 0.5 kg per additional portion
Material	Brass or stainless steel
B10d	2,500,000
Shock & vibration	EN 60068
PL rating	PLd

APPLICATION

The W Key Selector Box safety component is part of an integrated safety system.

A typical application of the W key selector box is switchgear to ensure that multiple supplies are not applied to common bus bars.

In the application illustrated key I1 will operate incomer 1, key I2 will operate incomer 2 and key I3 will operate incomer 3. Key B1 operates bus coupler 1 while key B2 operates bus coupler 2. When the key is inserted, the corresponding switch is closed.

The system shown is in condition 1 (see table) and has the three incomer switches closed and the busbar switches open. To change the system to condition 2 the I1 key is returned to the selector box and the selector knob moved to condition 2. In this position, the B1 key can be removed and the B1 Busbar switch closed.

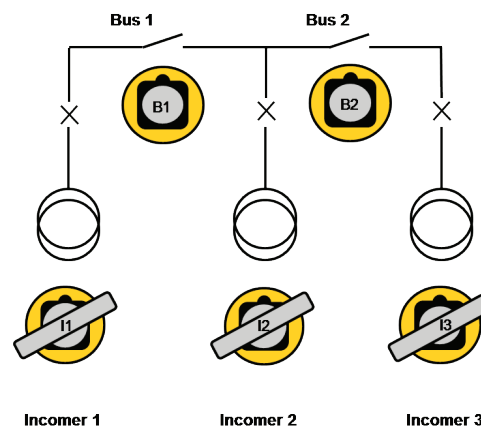

	Inc 1 (I1)	Inc 2 (I2)	Inc 3 (I3)	Bus 1 (B1)	Bus 2 (B1)
1	F	F*	F*	T	T
2	T	F	F*	F*	T
3	F*	T	F	F	T
4	F*	F*	T	T	F

F = free key

T = trapped key

* = key not returned between two neighbouring key free selections

DRAWING

Dimensions: in mm

Note: For safe mounting, use security screws

W key selector box, horizontal mount

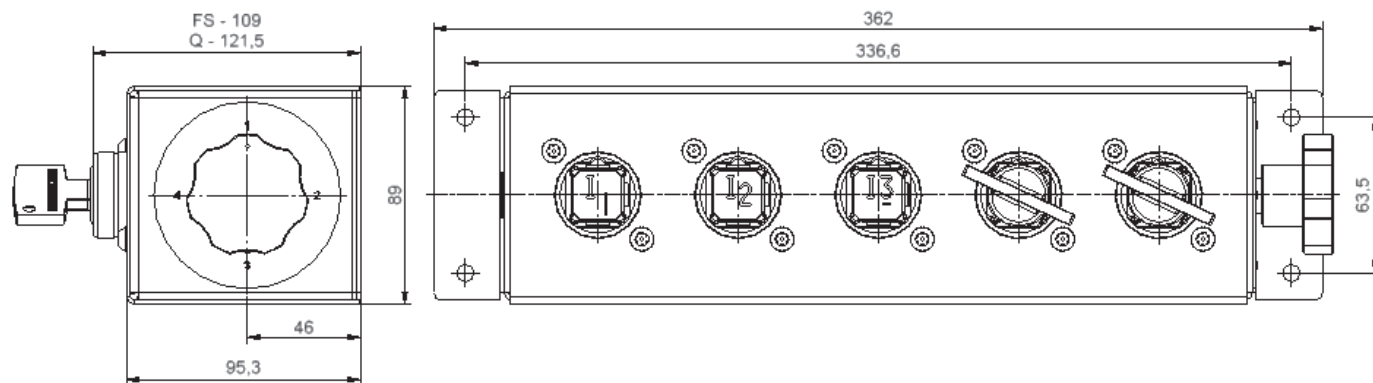

W Key Selector Box



ORDER INFORMATION

Part number **Component type** 1 2
 -

Example -

 Truth Table

1	Lock portion type	FS ⁽¹⁾ / Q ⁽¹⁾
2	Material	B = Brass S = Stainless steel
3	Truth table: please provide or contact our technical support	See example on page 1

<p>(1) FS - Lock type Up to 3 characters</p> 	<p>Q - Lock type Up to 6 characters</p> 
--	---

Special construction available upon enquiry

ACCESSORIES

	Product	Part number
	Flip Cap	FLIP-S

CONTACT INFORMATION

Castell Safety

The Castell Building, 217 Kingsbury Road, London, NW9 9PQ UK
t: +44 (0)20 8200 1200 | f: +44 (0)20 8205 0055 | e: sales@castell.com