

The KLC dual key claw interlock is a multi-key operated mechanical bolt interlock suitable for the control of electrical switchgear. The standard unit comes with a 16mm diameter bolt fitted with a claw that is used to control the rotation or movement of operating handles or toggles of electrical switchgear. The lock is manufactured in brass or stainless steel.

OPERATION

The Castell claw interlocks range is used in switchgear control to lock off power supply and control accesses to hazardous areas. The length and the travel of the bolt can be varied to suit the application.

KLC dual key claw interlock, exchange key condition

- 1** Key A is free, key B is trapped and claw is retracted.

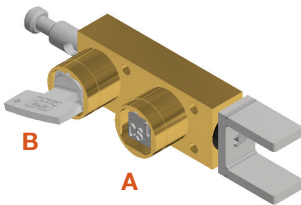

While key A is free, the claw is locked in retracted position, allowing the switch to turn or move.

- 2** Insert and turn key A and drive the bolt manually to extend the claw. Turn and release key B.

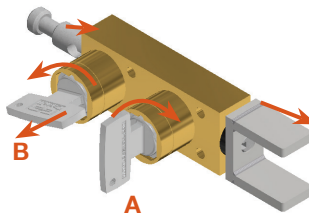

By inserting and turning key A in the KLC claw interlock, you can unlock the claw and manually extend the bolt. The claw now constrains the switch in the off position. Releasing key B will lock the claw in the extended position and trap key A. The released key B can be used as personnel key to gain access to the hazardous area via an access interlock.

- 3** Key B is free, key A is trapped and the claw is locked in extended position.

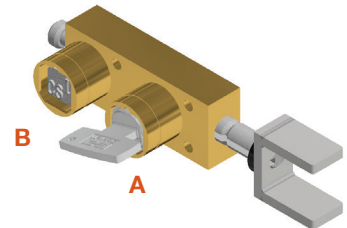

The switch cannot be switched on until key B is replaced in the KLC claw interlock, the bolt is retracted and key A released locking the claw in the retracted position.

KLC dual key claw interlock, double key condition

- 1** Keys A and B are trapped, the claw is retracted.

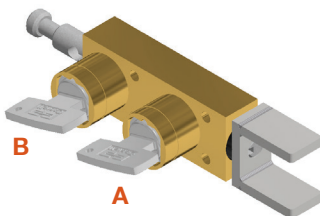

While both keys are trapped, the claw is locked in retracted position, unconstraining the switch.

- 2** Drive the bolt to extend the claw. Turn and release key A and B to lock the claw in extended position.

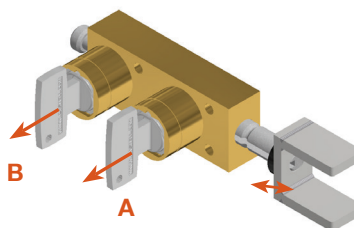

Driving the bolt, the claw is extended. Turning and releasing both keys will lock the claw in extended position constraining the switch in the off position. The released keys can be used as personnel keys to gain access to the hazardous area via an access interlock.

- 3** Both keys are released and the claw is locked in extended position.

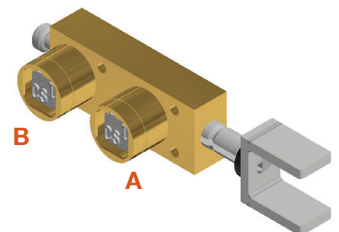

The switch cannot be switched on until key A and B are replaced in the KLC claw interlock and the claw is retracted.

USAGE

The KLC dual key claw interlock is designed to be part of a safety system and is used to lock off switches which then allows to gain access to a hazardous area.

 The KLC claw interlock is not designed for security purposes, such as access to a building.

No hazardous substances were used in the manufacture of this product.

INSTALLATION

The housing of the KLC dual key claw interlock should normally be mounted to a panel using suitable fasteners (please refer to drawing on page 4 for more details).

 **IMPORTANT:** The interlock should be mounted using anti-tamper fasteners to prevent unauthorised removal.

 The KLC claw interlock must be installed by a competent and qualified person who has read and understood these instructions. Please retain this document in your technical file.

 You must use M6 anti-tamper stainless steel screws secured using threadlock set to a torque of 5 N/M.

 The manufacturer should be consulted when use in a corrosive environment is planned.

MAINTENANCE

Periodic visual checks should be carried out by the site manager / safety officer.

Do not lubricate lock barrel with oil or grease, use CK dry powder graphite if necessary.

 In case of defects being detected please contact your nearest Castell Support Department for further actions. Please see Contact section for contact details.

 The interlock must be inspected every 6 months. Safety checks should include ensuring the keys and lock bolt can only be operated in the correct safety operating conditions (see page 1).

TECHNICAL DATA

Temperature rating	Minimum: -40°C [-40°F] ice free for Q & FS lock type
	Maximum: 107°C [224,6°F] for Q lock type/140°C [284°F] for FS lock type
Type of mounting	Surface mount using suitable fasteners (please refer to drawing on page 4 for more details)
Weight	N/A
Material	Brass/Stainless steel
B10d	2,500,000
Shock & vibration	EN 60068
PL rating	PLd

APPLICATION

The KLC claw interlock safety component is used as a part of an integrated safety system, typically in machine guarding applications. It is usually used in combination with an access interlock such as the AI for part body access or an access interlock with an exchange key for full body access control such as AIE.

While the power supply is switched on, both keys are trapped in the KLC claw interlock. To lock off the power supply switch, drive the bolt to extended position. The design has to be such that the bolt cannot be extended when the system is turned on. This will release the keys keeping the bolt extended and the switch locked off. The released keys are taken by the personnel to unlock the AI access interlocks on the access doors. While the access doors are opened, the keys remain trapped in the AI locks.

The bolt of the KLC claw interlock cannot be retracted to unlock the power supply until both doors to the machine are locked, keys removed from AI access interlocks and the replaced into the KLC claw interlock.

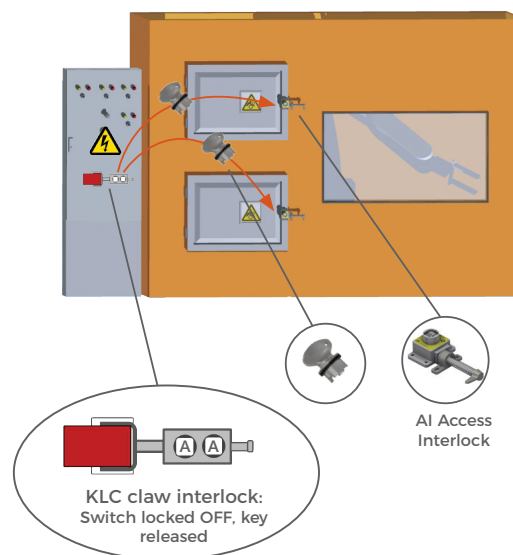

DRAWING

Dimensions: in mm

Note: For safe mounting, use security screws

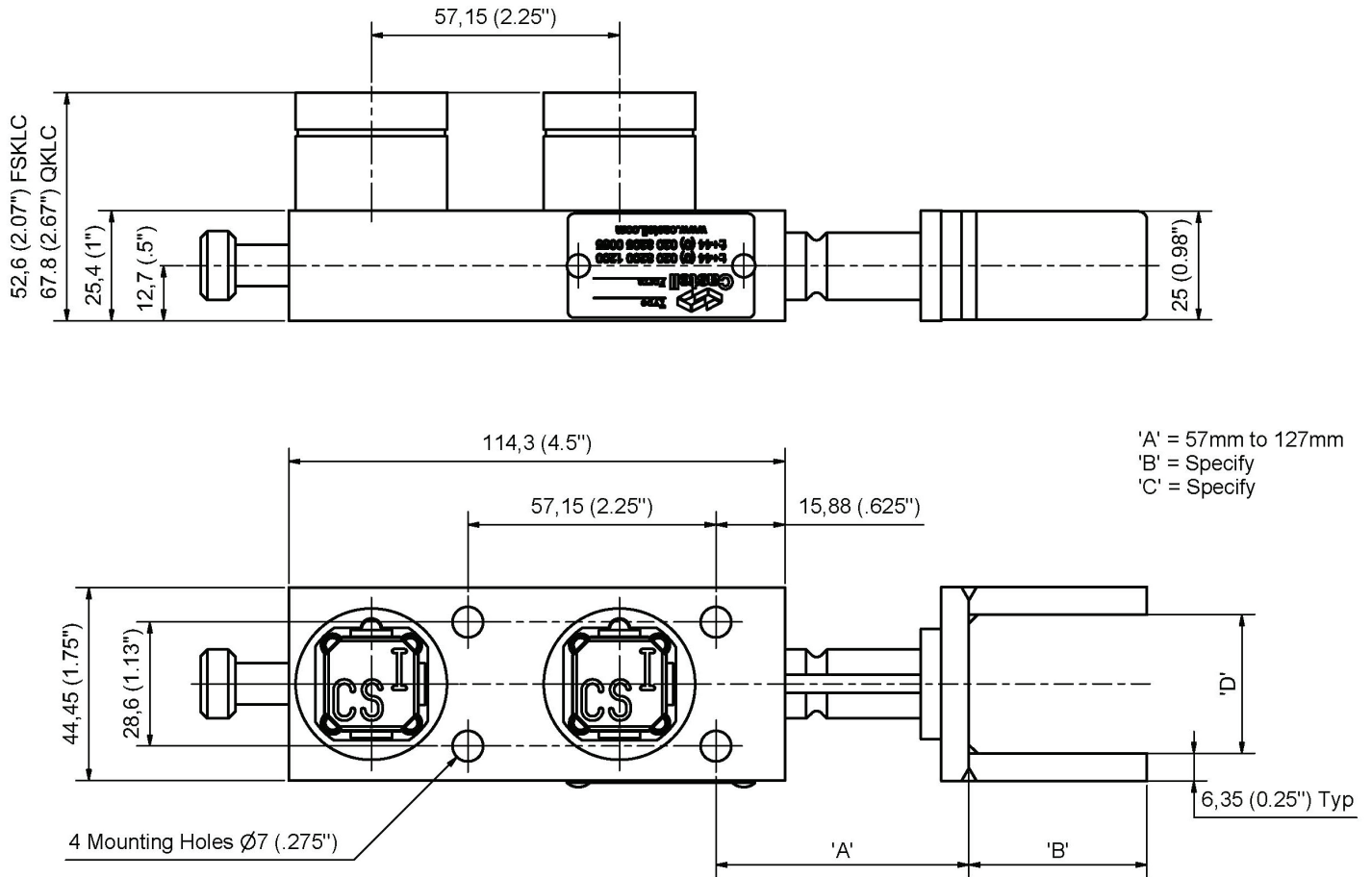











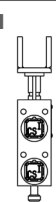

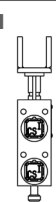

ORDER INFORMATION

	Component type	1	2	3	4	5	6	7	8	9
Part number	KLC									
Example	KLC	FS	B	1S	4	E	57	55	28.9	TBA

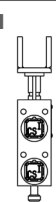
1	Lock portion type	FS ⁽¹⁾ / Q ⁽¹⁾
2	Material	B = Brass / S = Stainless steel
3	Secondary lock portion(s)	1S / 2S / 3S = 1 / 2 or 3 secondary lock portions respectively
4	Form	1 / 2 / 3 / 4 ⁽²⁾
5	Key condition	D = Double key condition (both keys are trapped or free) E = Exchange key condition (primary key is trapped while bolt/claw is extended, secondary key is free)
6	A dimension (bolt travel)	Please specify: 57 mm - 127 mm (in mm)
7	B dimension	Please specify (in mm)
8	D dimension	Please specify (in mm)
9	Lock portion symbols: Please advise for each lock ⁽³⁾ noting which is primary and which one(s) are secondary	FS ⁽¹⁾ up to 3 characters / Q ⁽¹⁾ up to 6 characters

⁽³⁾ Please note: Primary key is trapped while bolt is extended, secondary key is free

(1) FS - Lock type Up to 3 characters	Q - Lock type Up to 6 characters	(2) Form								
		<table border="1"> <tbody> <tr> <td>1</td> <td>2</td> <td>3</td> <td>4</td> </tr> <tr> <td></td> <td></td> <td></td> <td></td> </tr> </tbody> </table>	1	2	3	4				
1	2	3	4							
										

Special construction available upon enquiry

ACCESSORIES

	Product	Part number
	Flip Cap	FLIP-S

CONTACT INFORMATION

Castell Safety

The Castell Building, 217 Kingsbury Road, London, NW9 9PQ UK
t: +44 (0)20 8200 1200 | f: +44 (0)20 8205 0055 | e: sales@castell.com